

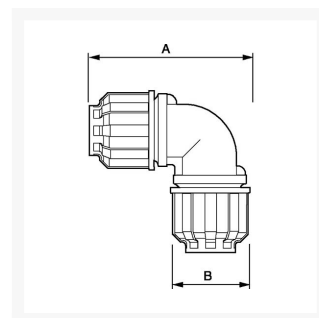

Coude égal 90° pour tubes Diam. Ext. 25 mm pour réseau air comprimé

Product Images



Additional Information

Référence	9ALR9C25
EAN	08712418282580
Poids (kg)	0.141000
Longueur (mm)	109
Largeur (mm)	65
Construction	Polyamide
Diamètre Ø (mm)	25
Pression maximale (bar)	13 à 40°C

