

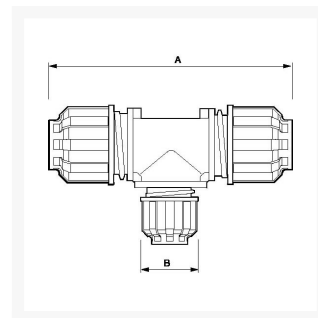

Réducteur en T pour tubes Diam. ext. 40 x 40 mm vers tube de Diam. ext. 25 mm de réseau air comprimé

Product Images



Additional Information

Référence	9ALRTR4025
EAN	08712418282764
Poids (kg)	0.508000
Longueur (mm)	182
Largeur (mm)	52
Construction	Polyamide
Diamètre Ø (mm)	40 x 25 x 40
Pression maximale (bar)	13 à 40°C

