

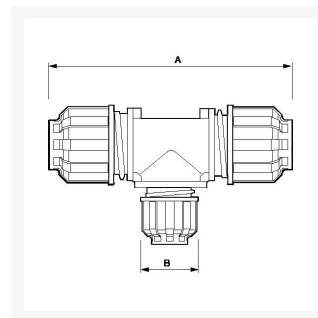

# Réducteur en T pour tubes Diam. ext. 32 x 32 mm vers tube de Diam. ext. 20 mm de réseau air comprimé

## Product Images



## Additional Information

---

Référence	9ALRTR3220
EAN	08712418282740
Poids (kg)	0.330000
Longueur (mm)	158
Largeur (mm)	47
Construction	Polyamide
Diamètre Ø (mm)	32 x 20 x 32
Pression maximale (bar)	13 à 40°C

