

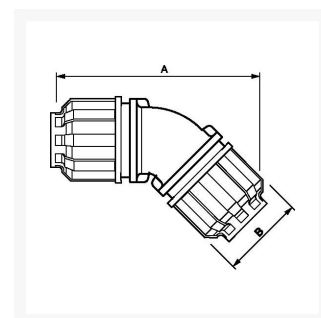

Coude égal 45° pour tubes Diam. Ext. 40 mm pour réseau air comprimé

Product Images



Additional Information

Référence	9ALR4C40
EAN	08712418282641
Poids (kg)	0.371000
Longueur (mm)	158
Largeur (mm)	80
Construction	Polyamide
Diamètre Ø (mm)	40
Pression maximale (bar)	13 à 40°C

