

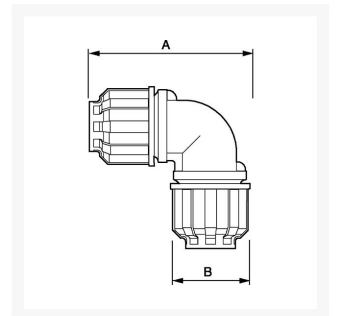

Coude égal 90° pour tubes Diam. Ext. 50 mm pour réseau air comprimé

Product Images



Additional Information

Référence	9ALR9C50
EAN	08712418321906
Poids (kg)	0.583000
Longueur (mm)	150
Largeur (mm)	93
Construction	Polyamide
Diamètre Ø (mm)	50
Pression maximale (bar)	13 à 40°C

